

PN : GT0505N-2K

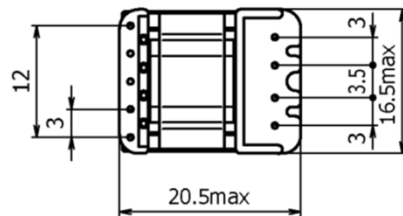

RoHS compliant

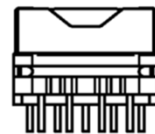
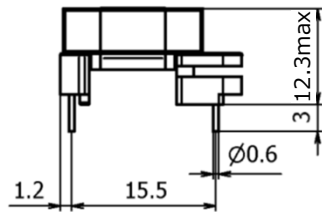
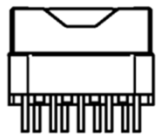
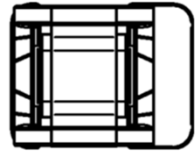
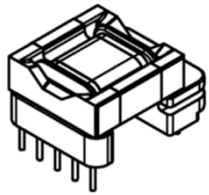

Bobbin : GT15
Ferrite core : EED15

Dimensions

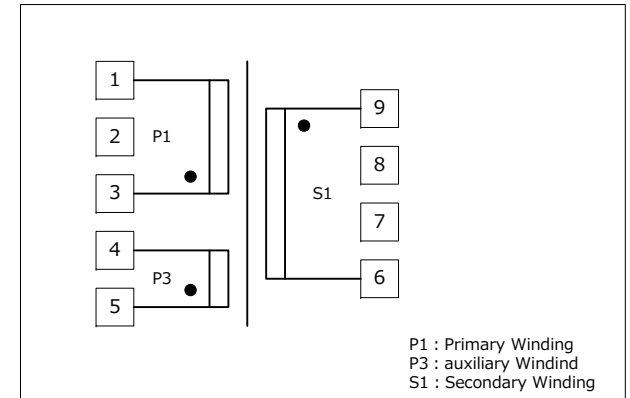

Schematics (Top View)

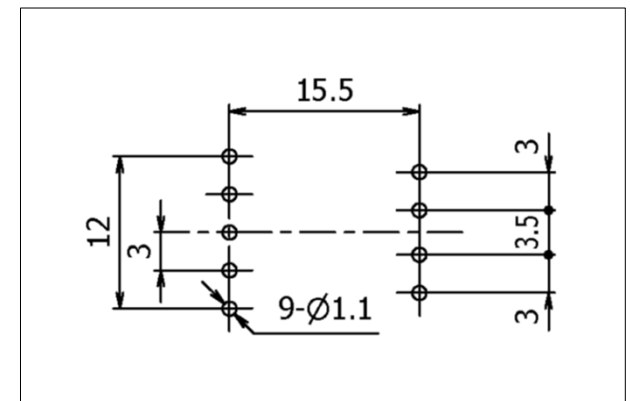

Recommended PCB hole size (Bottom view)

1. Specifications are subject to change for improvement without notice.
2. Please request us detailed specification.



TEST REPORT

Product Name	Test Board
Product Number	EVA-GT0505N-2K
Design Number	PS1205A
Sheet Number	
Date	2017/9/13

Meet Safety Standards
IEC 60950 PSE

Specification

Trans type : GT15

IC name : MIP2K2 (Panasonic)

Input voltage : AC100V – 240V (85V ~ 264V)

Input frequency : 50Hz / 60Hz (47Hz ~ 63Hz)

Output power : 5W

Output voltage : 5V (4.75V ~ 5.25V)

Output current : 1.0A

Ripple noise : 620mVp-p typ (AC100V) 440mVp-p typ (AC240V)

Standby power : 0.02W typ (AC100V) 0.05W typ (AC240V)

Efficiency : 81.1% (AC100V) 80.5% (AC240V)

Over load protect : Auto restart

Over voltage protect : Latch

Over temperature protect : 140°C (typ)

Operating temperature : -10°C ~ +50°C

Storage temperature : -30°C ~ +85°C

Hi-pot test : 3000V 1min.

Dimensions : 43.0 × 23.0 × 12.0 (mm)

Weight : 14.1g

Alphatrans co., ltd.

4-4-11 Bakurou-machi, Chuo-ku, Osaka

541-0059 Japan

TEL (06) 6252-8839 FAX (06) 6252-3939

<http://www.alphatrans.jp/>

Approve	Check	Drawn
T.Hagimoto	E .Fujishita	M .Omori

Load Regulation

AC in (V)	5V (V)	5V (A)	Bias (V)	I in (mA)	P in (W)	P out (W)	P loss (W)	効率 (%)
100	4.980	0.00	11.70	0.81	0.023	0.000	0.023	0.0
100	4.979	0.10	12.37	18.50	0.635	0.498	0.137	78.4
100	4.978	0.20	12.59	31.08	1.235	0.996	0.239	80.6
100	4.977	0.40	12.84	53.49	2.436	1.991	0.445	81.7
100	4.975	0.70	13.35	84.34	4.262	3.483	0.780	81.7
100	4.972	1.00	13.81	113.39	6.134	4.972	1.162	81.1
240	4.980	0.00	11.66	0.42	0.047	0.000	0.047	0.0
240	4.979	0.10	12.52	12.89	0.672	0.498	0.174	74.1
240	4.978	0.20	12.82	21.84	1.285	0.996	0.289	77.5
240	4.976	0.40	13.29	34.15	2.522	1.990	0.532	78.9
240	4.973	0.70	13.74	53.10	4.345	3.481	0.864	80.1
240	4.971	1.00	14.17	68.14	6.176	4.971	1.205	80.5

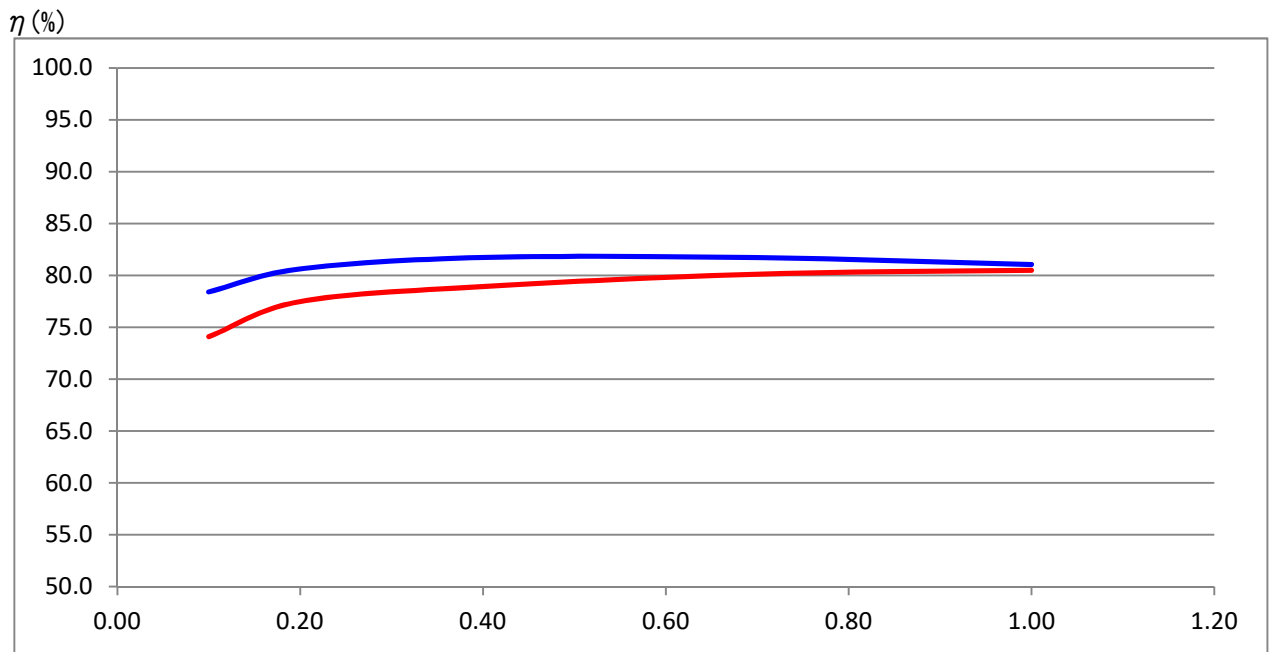

Over Current Protection

AC100V: 1.45A

AC240V: 1.75A

Over Voltage Protection

AC100V: 9.6V 5ms

AC240V: 9.6V 4ms

AC100V 5V 0.5A C.C mode

AC240V 5V 0.5A C.C mode

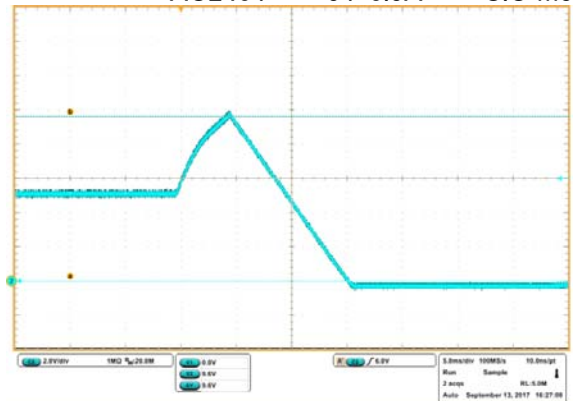
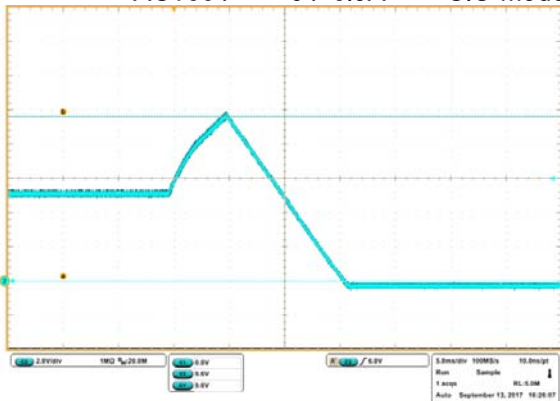

※U3 R-A short

Conducted EMI noise

input:
AC100V
output:
5V 1.0A

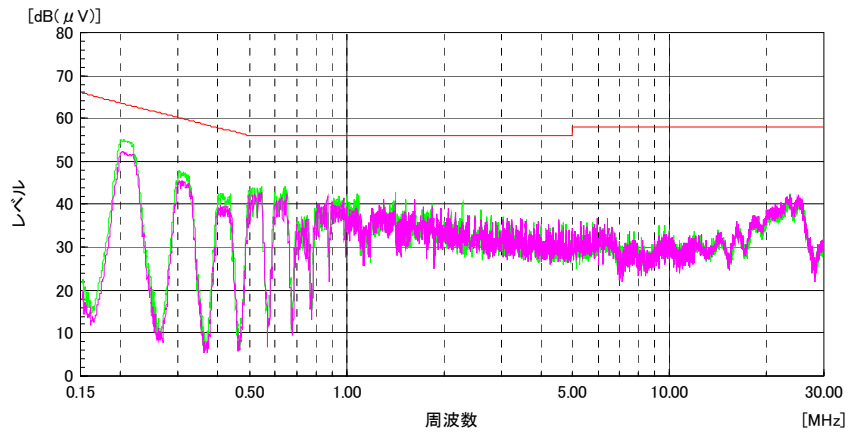

input:
AC240V
output:
5V 1.0A

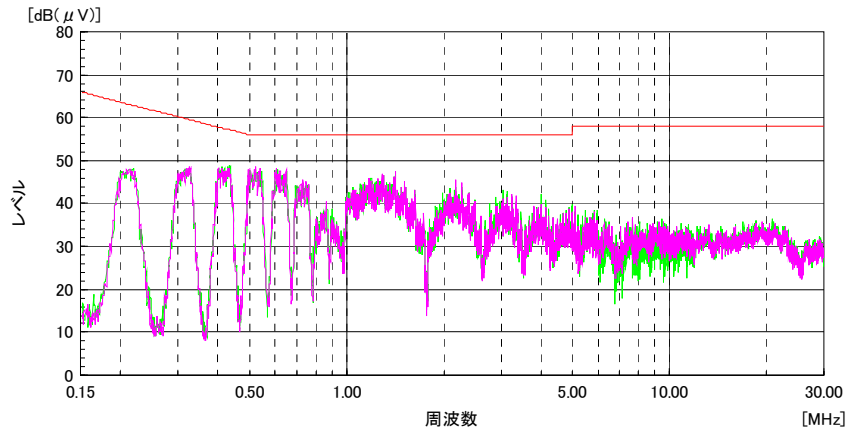

Output ripple noise

input:
AC100V
output:
5V 1.0A

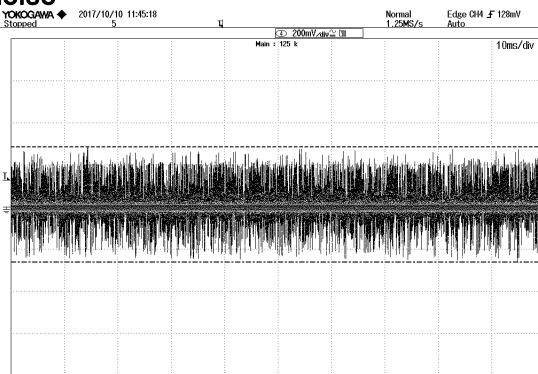

Ripple Noise:
548mV_{p-p}

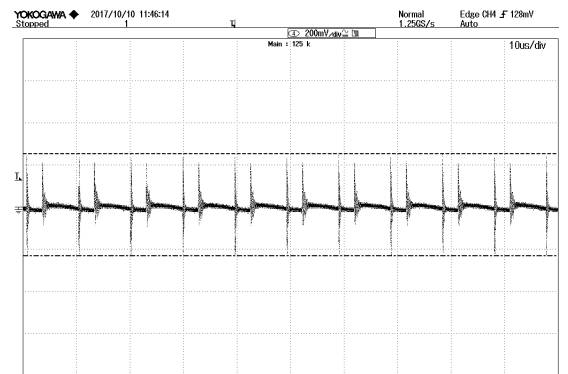

input:
AC240V
output:
5V 1.0A

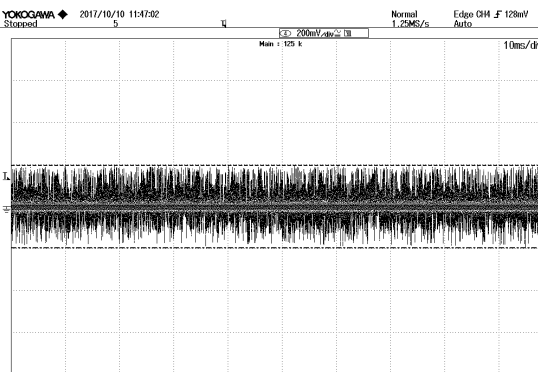

Ripple Noise:
394mV_{p-p}

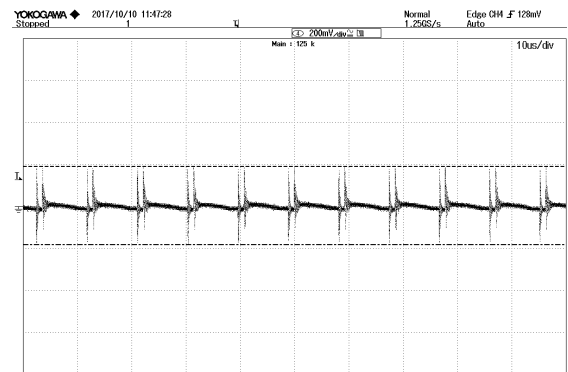

Differential Probe: (DP-100 Keisoku Giken)

Test board image

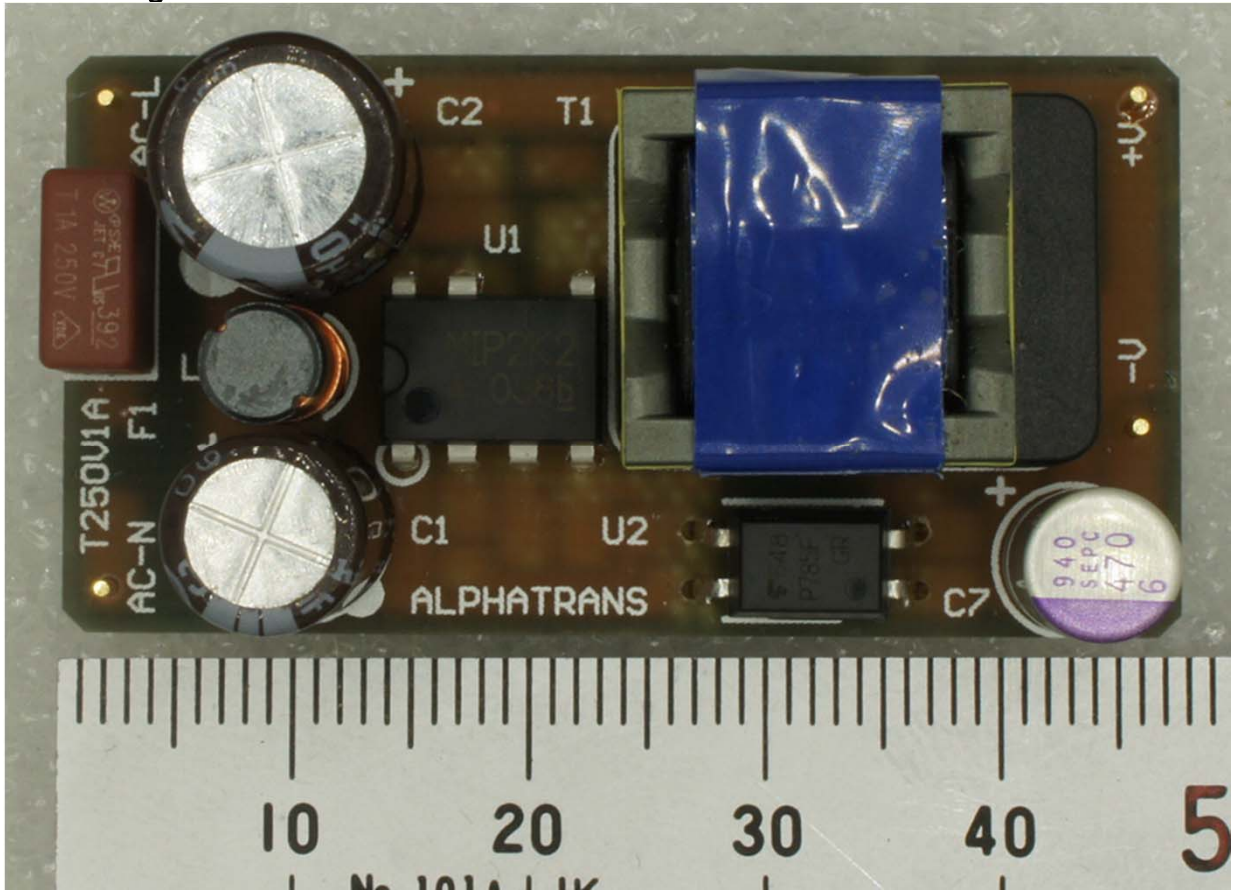

Temperature & Life

input: AC100~240V
 output: 5V 1.0A
 mean temperature : 40 °C
 max operating temperature: 50 °C

C1	105 °C	UVC2G4R7MPD	2000 (hour)
C2	105 °C	UVC2G100MPD	2000 (hour)
C7	105 °C	6SEPC470MW	5000 (hour)

		input AC85V (°C)	input AC100V		input AC240V		input AC264V		limit temp (°C)	max temp (°C)	margin	mean temp	40°C Life (hour)	40°C Life (Year)
			(°C)	(ΔT)	(°C)	(ΔT)	(°C)	(ΔT)						
①	Reference	(°C) 27.7	—	28.4	—	29.1	—	29.7	—	—	—			
②	D1	(°C) 49.3	21.6	46.9	18.6	42.6	13.6	43.6	13.9	150	71.6	78.4		
③	C1	(°C) 45.5	17.9	44.3	16.0	42.0	12.9	43.3	13.6	105	67.9	37.2	57.9	6.0
④	L1	(°C) 48.1	20.4	46.6	18.2	44.1	15.0	45.3	15.6	120	70.4	49.6		
⑤	C2	(°C) 49.9	22.3	48.1	19.7	46.5	17.5	47.4	17.7	105	72.3	32.8	62.3	4.4
⑥	D2	(°C) 62.3	34.6	59.8	31.5	59.4	30.3	60.3	30.6	150	84.6	65.4		
⑦	D5	(°C) 53.1	25.4	51.1	22.7	50.1	21.1	50.6	20.9	150	75.4	74.6		
⑧	R13	(°C) 58.0	30.4	55.8	27.4	54.8	25.7	55.3	25.6	150	80.4	69.7		
⑨	U1	(°C) 67.3	39.6	63.9	35.6	62.9	33.9	65.8	36.1	130	89.6	40.4		
⑩	T1 wire	(°C) 59.3	31.7	59.2	30.8	61.9	32.9	63.1	33.4	120	83.4	36.6		
⑪	T1 core	(°C) 57.7	30.0	57.0	28.7	60.4	31.3	60.2	30.5	120	80.5	39.6		
⑫	D4	(°C) 72.8	45.2	72.6	44.2	74.8	45.8	74.8	45.1	150	95.1	55.0		
⑬	C7	(°C) 46.9	19.2	46.8	18.4	47.9	18.8	49.1	19.4	105	69.4	35.6	59.4	13.5
⑭	U3	(°C) 51.3	23.6	51.0	22.6	52.2	23.2	53.4	23.7	125	73.7	51.3		

Schematic Diagram

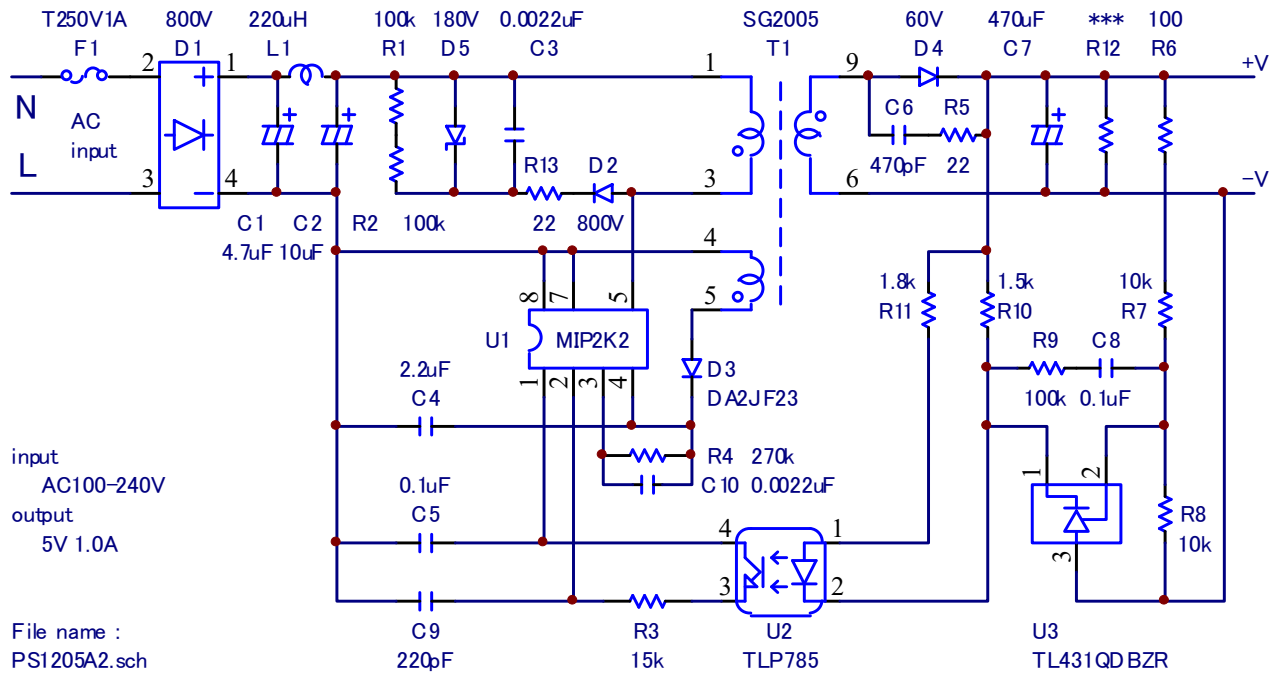

Parts List

REF.No	Description	TYPE	Specification	Manufacture
C1	Electrol Capacitor	UVC2G4R7MPD	4.7uF 400V 2000H ϕ 8x11.5 P=3.5	Nichicon
C2	Electrol Capacitor	UVC2G100MPD	10uF 400V 2000H ϕ 10x12.5 P=5.0	Nichicon
C3	Ceramic Capacitor	C2012JB2E222K	0.0022uF 250V B 2012	TDK
C4	Ceramic Capacitor	C2012JB1H225K	2.2uF 50V B 2012	TDK
C5	Ceramic Capacitor	C1608JB1H104K	0.1uF 50V B 1608	TDK
C6	Ceramic Capacitor	C1608CH2E471J	470pF 250V CH 1608	TDK
C7	Electrol Capacitor	6SEPC470MW	470uF 6.3V 5000H ϕ 6.3x9.0 P=2.5	Panasonic
C8	Ceramic Capacitor	C1608JB1H104K	0.1uF 50V B 1608	TDK
C9	Ceramic Capacitor	C1608CH1H221K	220pF 50V CH 1608	TDK
C10	Ceramic Capacitor	C1608CH1H222K	0.0022uF 50V CH 1608	TDK
D1	Diode Bridge	D1UBA80-7062	800V 1A	Shindengen
D2	Diode	RFU02VSM8STR	800V 0.2A TUMD2SM D2014	ROHM
D3	Diode	DA2JF23	300V 0.3A SMini2-F5-B D1712	Panasonic
D4	Diode	RBR5L60A	60V 5A PMDS D4526	ROHM
D5	Zener Diode	DFLZ180	180V 1W SOD-123FL D2818	MCC
F1	Fuse	39211000440	1A 250V T	Littelfuse
L1	Choke Coil	LF1244Y	220uH CH5011	Alphatrans
R1	Resistor	MCR10EZPJ104	100k 1/8W 150V 2012	ROHM
R2	Resistor	MCR10EZPJ104	100k 1/8W 150V 2012	ROHM
R3	Resistor	MCR03EZPJ153	15k 1/10W 50V 1608	ROHM
R4	Resistor	MCR03EZPJ274	270k 1/10W 50V 1608	ROHM
R5	Resistor	MCR18EZPJ220	22 1/4W 200V 3216	ROHM
R6	Resistor	MCR03EZPJ101	100 1/10W 50V 1608	ROHM
R7	Resistor	MCR03EZPFX1002	10k 1/10W 50V 1% 1608	ROHM
R8	Resistor	MCR03EZPFX1002	10k 1/10W 50V 1% 1608	ROHM
R9	Resistor	MCR03EZPJ104	100k 1/10W 50V 1608	ROHM
R10	Resistor	MCR03EZPJ152	1.5k 1/10W 50V 1608	ROHM
R11	Resistor	MCR18EZPJ182	1.8k 1/4W 200V 3216	ROHM
R12	***	***	***	***
R13	Resistor	MCR10EZPJ220	22 1/8W 150V 2012	ROHM
T1	Transformer	GT0505N-2K	SG2005A GT15	Alphatrans
U1	IC	MIP2K2	700V DIP8	Panasonic
U2	Optical	TLP785F (GR,F	5000V	Toshiba
U3	Shunt Reg.	TL431QDBZR	2.495V 2% SOT23-3	Texas Instruments
	PCB	PW1126C	FR-4 t=1.0	
	Terminal	DC-5		マックエイト